

# SUMMARY STAINLESS STEEL FITTINGS

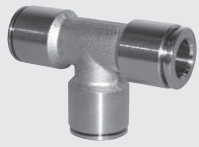

● PUSH-IN FITTINGS, STAINLESS STEEL

D3.2

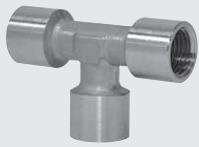

● STANDARD FITTINGS SERIES XA

D3.8

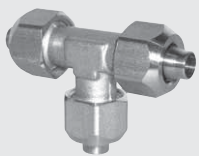

● QUICK FITTINGS SERIES XC

D3.11

# PUSH-IN FITTINGS, STAINLESS STEEL

The push-in fittings in the XR can be reused thousands of times without affecting the pneumatic seal in any way.

They come in various configurations.

The XR fittings are made entirely of 316L stainless steel (EN 1.4404) and can be used to make connections in environments and conditions where the use of standard brass fittings would be incompatible.

The gasket are in FKM/FPM.



TECHNICAL DATA		
Threaded coupling		M5 - 1/8" - 1/4" - 3/8" - 1/2"
Diameter	mm	Ø4 - Ø6 - Ø8 - Ø10 - Ø12
Temperature range	°C	- 20 to +150
	°F	- 4 to +302
Pressure range		- 0.99 bar to 18 bar / - 0.099 MPa to 1.8 MPa
Recommended pipe		PTFE
Fluid		Vacuum - Compressed air

## COMPONENTS

- ① RELEASE BUSHING: AISI 316L stainless steel
- ② LOCKING BUSHING: AISI 316L stainless steel
- ③ BODY: AISI 316L stainless steel
- ④ CLAMPING SPRING: AISI 301 stainless steel
- ⑤ SPRING SUPPORTING RING: AISI 316L stainless steel
- ⑥ SEAL: FKM/FPM

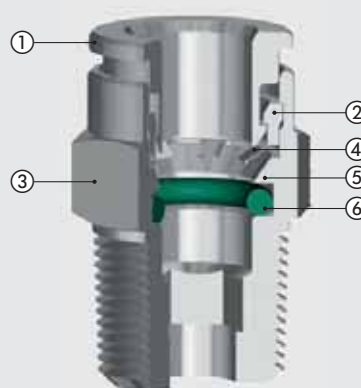

## PIPE INSERTION DEPTH

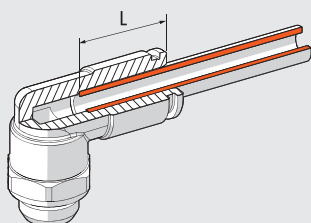

Ø Pipe	L
4	13.2
6	16.1
8	16.2
10	18.3
12	19.5

## SCREWING METHOD

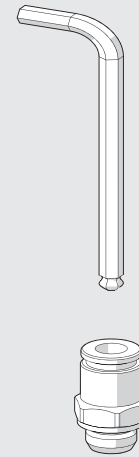
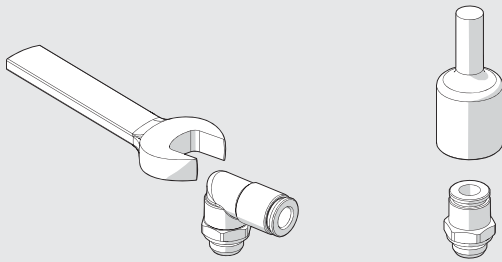

Thread	Max. Torque [Nm]
M5	1.8
G 1/8"	6
G 1/4"	8
G 3/8"	10
G 1/2"	15

CH [mm]	Max. Torque [Nm]
3	2.5
4	5
6	8
8	18
10	15

**N.B.:** When using a socket spanner, the torque must not exceed that of the thread (e.g. fitting XR1 Ø 4 1/8", with a 3 mm thread, has a maximum torque of 6 Nm, highest value of the thread)

## INSTALLING THE PIPE

Compressed air pipes must be used in compliance with some basic criteria in order to ensure long life and proper operation of the fitting:

- check that the conditions for the installation and use (e.g. temperature and fluid used) comply with the characteristics stated by the pipe manufacturer;
- check the pipe size; oversized pipes could not fit properly, undersized ones could not ensure pipe retention and air tightness.

The cut should be as accurate as possible at a right angle with the pipe axis.

**Wrong**

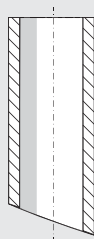

**Correct**

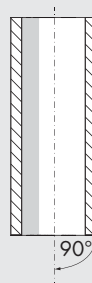

- the bending radius of the pipe installed must be as wide as possible. The fittings have been designed to ensure axial seal of the pipe; excessive curvature could considerably shorten the life of the pipe.
- the pipe must not be subjected to excessive axial stress and it must be of the right length for snugly fitting (not too long or too short).
- correct insertion of the pipe into the fitting is essential for air tightness and pipe retention. Make sure that the pipe is pushed right into the seat.
- check that the pipe does not encounter any obstacles or blockages along its way, which could cause tensile stress of the pipe in the fitting.

**STRAIGHT, CYLINDRICAL, MALE (XR1)**

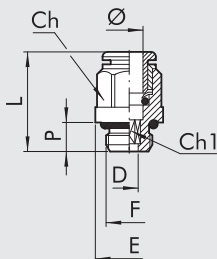

Code	Ref.	Ø	F	Ch	Ch1	P	L	D	E
2L01001X	XR1	4	M5	9	-	4	19	2.5	10.5
2L01002X	XR1	4	1/8	13	3	5	16	3.1	14.5
2L01000X	XR1	6	M5	12	-	4	22.5	2.5	13.5
2L01007X	XR1	6	1/8	13	4	5	19	4.2	14.5
2L01008X	XR1	6	1/4	16	4	6.5	18.5	4.2	18
2L01009X	XR1	8	1/8	14	6	5	22.5	6.2	15.5
2L01010X	XR1	8	1/4	16	6	6.5	21	6.2	18
2L01012X	XR1	10	1/4	16	8	6.5	27.5	8.4	18
2L01013X	XR1	10	3/8	17	8	7	25	8.4	20
2001014X	XR1	12	3/8	21	10	7	28.5	10.4	23.5
2001015X	XR1	12	1/2	22	10	8.5	26.5	10.4	25

**STRAIGHT, CONICAL, MALE (XR1C)**

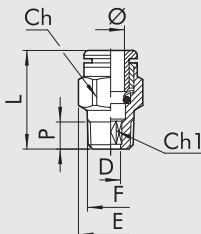

Code	Ref.	Ø	F	Ch	Ch1	P	L	D	E
2L01C02X	XR1C	4	1/8	10	3	7.5	15.5	3	11.5
2L01C03X	XR1C	4	1/4	14	3	11	20	3	16
2L01C07X	XR1C	6	1/8	12	4	7.4	20.5	4.2	14
2L01C08X	XR1C	6	1/4	14	4	11	20	4.2	16
2L01C09X	XR1C	8	1/8	14	6	7.1	24.5	6.2	16
2L01C10X	XR1C	8	1/4	14	6	11	23	6.2	16
2L01C13X	XR1C	10	1/4	16	8	11	30	8	18.5
2L01C14X	XR1C	10	3/8	17	8	11.5	23.5	8.4	20
2001C15X	XR1C	12	3/8	18	10	11.5	27	10.4	22
2001C16X	XR1C	12	1/2	22	10	14	27	10.4	25.5

**STRAIGHT, INTERMEDIATE (XR3)**

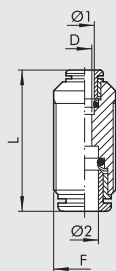

Code	Ref.	Ø 1	Ø 2	F	L	D
2L03001X	XR3	4	4	9	27	3
2L03301X	XR3	4	6	12	32.5	3
2L03003X	XR3	6	6	12	31	5
2L03303X	XR3	6	8	14	33	5
2L03004X	XR3	8	8	14	34	7
2L03005X	XR3	10	10	16	37.5	9
2003006X	XR3	12	12	19	39.5	11

**ELBOW, INTERMEDIATE (XR4)**

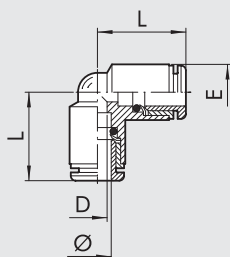

Code	Ref.	Ø	L	D	E
2L04001X	XR4	4	17	3.5	9
2L04003X	XR4	6	20	5.5	12
2L04004X	XR4	8	21	7	14
2L04005X	XR4	10	25	8	16
2L04006X	XR4	12	27	10	19

## TEE, INTERMEDIATE (XR5)

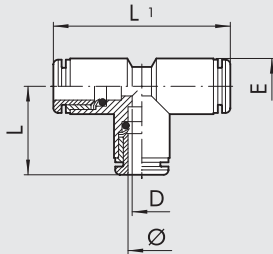

Code	Ref.	Ø	L	L1	D	E
2L05001X	XR5	4	17	34	3.5	9
2L05003X	XR5	6	20	40	5	12
2L05004X	XR5	8	21	42	6	14
2L05005X	XR5	10	25	50	8.5	16
2L05006X	XR5	12	27	54	10	19

## REDUCER (XR8)

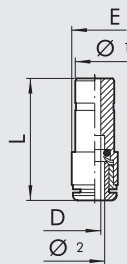

Code	Ref.	Ø 1	Ø 2	L	D	E
2L08002X	XR8	6	4	31	3	9
2L08006X	XR8	8	6	33	5	12
2L08008X	XR8	10	8	34.5	7	14

## STRAIGHT, INTERMEDIATE, BULKMTAD (XR10)

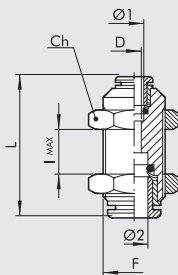

Code	Ref.	Ø 1	Ø 2	F	Ch	L	D	L max
2L11001X	XR10	4	4	M12x1	15	27	3	11
2L11003X	XR10	6	6	M14x1	17	32.5	5	16
2L11004X	XR10	8	8	M16x1	19	33	7	17
2L11005X	XR10	10	10	M18x1	21	37.5	9	19
2L11006X	XR10	12	12	M20x1	24	39.5	11	20

## SINGLE RING (XR13)

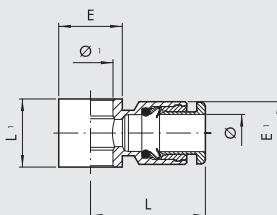

Code	Ref.	Ø	Ø 1	L	L1	E	E1
2012002X	XR13	4	1/8	19.5	15	14	9
2012005X	XR13	6	1/8	22	15	14	12
2012006X	XR13	6	1/4	23.5	17	18	12
2012007X	XR13	8	1/8	22.5	15	14	14
2012008X	XR13	8	1/4	24	17	18	14
2012010X	XR13	10	1/4	27	17	18	14
2012011X	XR13	10	3/8	29	20	22	16
2012012X	XR13	12	3/8	31	20	22	16
2012014X	XR13	12	1/2	33	24	26	19

## BANJO STEM SINGLE (XD7)

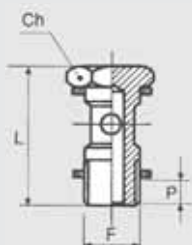

Code	Ref.	F	Ch	L	P
2407002X	XD7	1/8	14	29	6
2407003X	XD7	1/4	17	32.5	6.5
2407004X	XD7	3/8	21	36	7
2407005X	XD7	1/2	26	41.5	8.5

## ROTARY ELBOW, MALE, CYLINDRICAL (XR31)

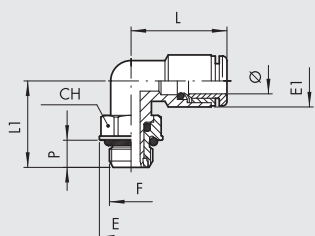

Code	Ref.	Ø	F	CH	E	E1	L	L1	P
2L31001X	XR31	4	M5	9	10	9	17	14	4
2L31002X	XR31	4	1/8	13	14.5	9	17	16	5
2L31007X	XR31	6	M5	9	10	12	20.5	15.5	4
2L31008X	XR31	6	1/8	13	14.5	12	21.5	18	5
2L31009X	XR31	6	1/4	16	18	12	21.5	20	6.5
2L31010X	XR31	8	1/8	13	14.5	14	22	18	5
2L31011X	XR31	8	1/4	16	18	14	22	20	6.5
2L31013X	XR31	10	1/4	16	18	16	25.5	22.5	6.5
2L31014X	XR31	10	3/8	21	23.5	16	25.5	24	7
2031017X	XR31	12	3/8	21	23.5	19	28	26.5	7
2031018X	XR31	12	1/2	22	25	19	28	31	8.5

## ROTARY ELBOW, MALE, CONICAL (XR31C)

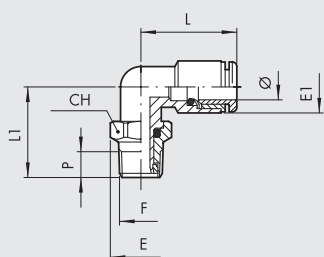

Code	Ref.	Ø	F	CH	E	E1	L	L1	P
2L31C02X	XR31C	4	1/8	10	11.2	9	17	17.5	7.5
2L31C08X	XR31C	6	1/8	13	14.5	12	21.5	20	7.5
2L31C09X	XR31C	6	1/4	14	14.5	12	21.5	24	11
2L31C10X	XR31C	8	1/8	13	14.5	14	22	20	7.5
2L31C11X	XR31C	8	1/4	14	15.5	14	22	24	11
2L31C13X	XR31C	10	1/4	16	18	16	25.5	26.5	11
2L31C14X	XR31C	10	3/8	17	19	16	25.5	27	11.5
2031C15X	XR31C	12	3/8	21	24.5	19	28	30.5	11.5
2031C16X	XR31C	12	1/2	22	24.5	19	28	33.5	14

## CENTRAL TEE, MALE, CYLINDRICAL, ROTARY (XR32)

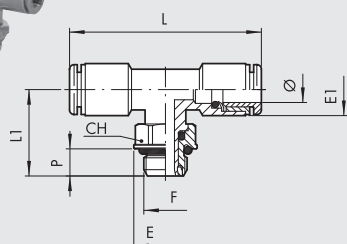

Code	Ref.	Ø	F	CH	E	E1	L	L1	P
2L32001X	XR32	4	M5	9	10	9	34	18	4
2L32002X	XR32	4	1/8	13	14.5	9	34	20	5
2L32008X	XR32	6	1/8	13	14.5	12	42	22.5	5
2L32009X	XR32	6	1/4	16	18	12	42	24.5	6.5
2L32010X	XR32	8	1/8	13	14.5	14	43	22.5	5
2L32011X	XR32	8	1/4	16	18	14	43	24.5	6.5
2L32013X	XR32	10	1/4	16	18	16	50	25.5	6.5
2L32014X	XR32	10	3/8	21	23.5	16	50	27	7

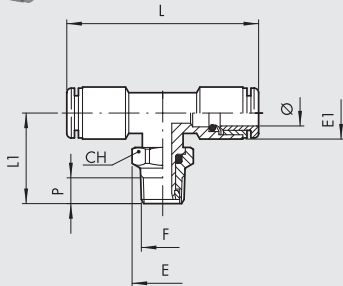
**CENTRAL TEE, MALE, CONICAL, ROTARY (XR32C)**

Code	Ref.	Ø	F	CH	E	E1	L	L1	P
2L32C02X	XR32C	4	1/8	10	11.2	9	34	21.5	7.5
2L32C08X	XR32C	6	1/8	13	14.5	12	42	24.5	7.5
2L32C09X	XR32C	6	1/4	14	15.5	12	42	28.5	11
2L32C10X	XR32C	8	1/8	13	14.5	14	43	24.5	7.5
2L32C11X	XR32C	8	1/4	14	15.5	14	43	28.5	11
2L32C13X	XR32C	10	1/4	16	18	16	50	32	11
2L32C14X	XR32C	10	3/8	17	19	16	50	32.5	1.5

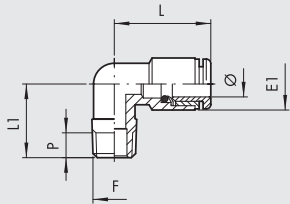
**ELBOW, MALE, CONICAL (XR39C)**

Code	Ref.	Ø	F	E1	L	L1	P
2L39C02X	XR39C	4	1/8	9	17	16	7.5
2L39C08X	XR39C	6	1/8	12	20	16	7.5
2L39C09X	XR39C	6	1/4	12	20	20	11
2L39C10X	XR39C	8	1/8	14	21	17	7.5
2L39C11X	XR39C	8	1/4	14	21	20	11
2L39C13X	XR39C	10	1/4	16	25.5	22.5	11

**NOTES**

# STANDARD FITTINGS SERIES XA

- Body made of AISI 316L (EN 1.4404) stainless steel
- Operating temperature for fittings with O-ring seals:  
-20 to 200 °C / -4 to 392 °F
- Maximum pressure 200 bar - 20000 KPa - 2900 psi



## NIPPLE, CONICAL (XA2)

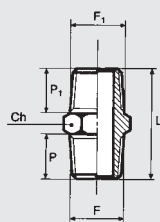

Code	Ref.	F	F1	Ch	P	P1	L
2102001X	XA2	1/8	1/8	12	7.5	7.5	20
2102002X	XA2	1/8	1/4	14	7.5	11	23.5
2102004X	XA2	1/4	1/4	14	11	11	27
2102005X	XA2	1/4	3/8	17	11	11.5	27.5
2102007X	XA2	3/8	3/8	17	11.5	11.5	28
2102008X	XA2	3/8	1/2	22	11.5	14	31.5
2102009X	XA2	1/2	1/2	22	14	14	34

## SLEEVE (XA3)

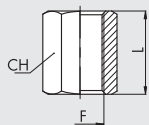

Code	Ref.	F	Ch	L
2103001X	XA3	1/8	14	15
2103002X	XA3	1/4	17	22
2103003X	XA3	3/8	22	24
2103004X	XA3	1/2	27	30

## REDUCER, CONICAL (XA4)

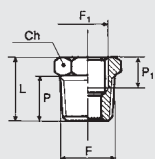

Code	Ref.	F	F1	Ch	P	P1	L
2104001X	XA4	1/4	1/8	14	11	8	16
2104002X	XA4	3/8	1/8	17	11.5	8	16.5
2104009X	XA4	1/2	1/8	22	14	8	19.5
2104003X	XA4	3/8	1/4	17	11.5	10	16.5
2104004X	XA4	1/2	1/4	22	14	10	19.5
2104005X	XA4	1/2	3/8	22	14	10	19.5



## REDUCER, PARALLEL (XA4Z)

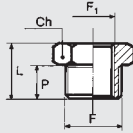

Code	Ref.	F	F1	Ch	P	L
2151000X	XA4Z	1/8	M5	14	6	10.5
2151001X	XA4Z	1/4	1/8	17	8	13
2151003X	XA4Z	3/8	1/4	19	9	14

## PLUG WITH EXAGON EMBEDDED (XA7)

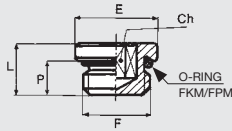

Code	Ref.	F	Ch	P	L	E
2107001X	XA7	1/8	5	5	7.5	13
2107002X	XA7	1/4	6	6.5	9.5	16
2107003X	XA7	3/8	8	7	10	20
2107004X	XA7	1/2	10	8.5	12	25

## TAPER MALE PLUG (XA7C)

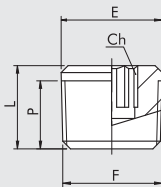

Code	Ref.	F	Ch	P	L	E
2107C01X	XA7C	1/8	5	5	7.5	13
2107C02X	XA7C	1/4	6	6.5	9.5	16
2107C03X	XA7C	3/8	8	7	10	20
2107C04X	XA7C	1/2	10	8.5	12	25

## ELBOW, FEMALE (XA9)

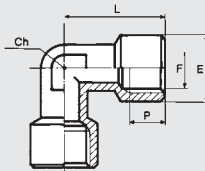

Code	Ref.	F	Ch	P	L	E
2109001X	XA9	1/8	10	8	22	13
2109002X	XA9	1/4	12	10	26	16.5
2109003X	XA9	3/8	17	10	28	20
2109004X	XA9	1/2	19	13	34	25

## ELBOW, MALE-FEMALE (XA10)

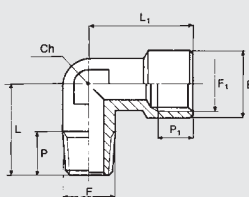

Code	Ref.	F	F1	Ch	P	P1	L	L1	E
2110001X	XA10	1/8	1/8	10	6	8	17	22	13
2110002X	XA10	1/4	1/4	12	9	10	21.5	26	16.5
2110003X	XA10	3/8	3/8	17	11	10	24.5	28	20
2110004X	XA10	1/2	1/2	19	13	13	30.5	34	25

TEE, FEMALE (XA11)

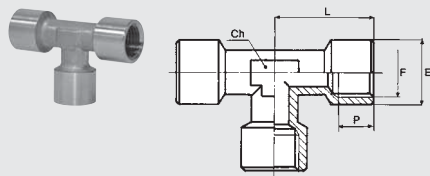

Code	Ref.	F	Ch	P	L	E
2111001X	XA11	1/8	10	8	22	13
2111002X	XA11	1/4	12	10	26	16.5
2111003X	XA11	3/8	17	10	28	20
2111004X	XA11	1/2	19	13	34	25

TEE, CENTRAL MALE (XA12)

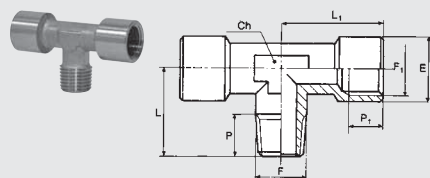

Code	Ref.	F	F1	Ch	P	P1	L	L1	E
2112001X	XA12	1/8	1/8	10	6	8	17	22	13
2112002X	XA12	1/4	1/4	12	9	10	21.5	26	16.5
2112003X	XA12	3/8	3/8	17	11	10	24.5	28	20
2112004X	XA12	1/2	1/2	19	13	13	30.5	34	25

ELBOW, MALE (XA15)

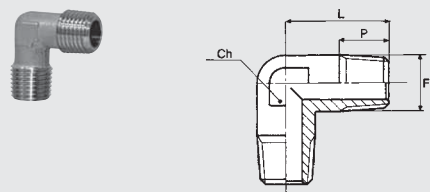

Code	Ref.	F	Ch	P	L
2115001X	XA15	1/8	10	6	17
2115002X	XA15	1/4	12	9	21.5
2115003X	XA15	3/8	17	11	24.5
2115004X	XA15	1/2	19	13	30.5

SINGLE BANJO PASSING TROUGH BODY (XD12)

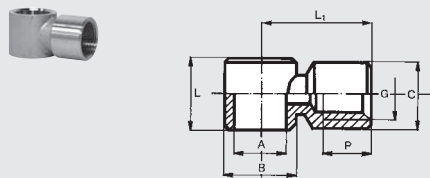

Code	Ref.	A	G	B	C	L	L1	P
2412001X	XD12	1/8	1/8	14	14	15	18.5	8
2412002X	XD12	1/4	1/4	17	17	17	24	10
2412003X	XD12	3/8	3/8	22	20	20	29	10
2412004X	XD12	1/2	1/2	25	26	24	34.5	14

NOTES

# QUICK FITTINGS SERIES XC



- Body made of AISI 316L (EN 1.4404) stainless steel
- Operating temperature according to the type of pipe used
- Maximum pressure 25 bar - 2500 KPa - 363 psi



## STRAIGHT, MALE CONICAL (XC1)

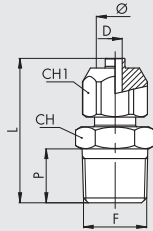

Code	Ref.	Ø	F	Ch	Ch1	P	L	D
2301001X	XC1	6/4	1/8	12	10	7.5	26	3
2301002X	XC1	6/4	1/4	12	14	11	29.5	3
2301003X	XC1	8/6	1/8	14	13	7.5	26.5	5
2301004X	XC1	8/6	1/4	14	14	11	30	5
2301006X	XC1	10/8	1/4	16	14	11	32.5	6.5
2301007X	XC1	10/8	3/8	16	17	11.5	33	6.5

## STRAIGHT, CONNECTOR (XC3)

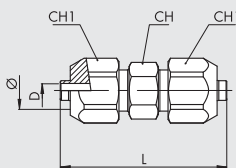

Code	Ref.	Ø	Ch	Ch1	L	D
2303001X	XC3	6/4	10	12	34	3
2303002X	XC3	8/6	12	14	35	5
2303003X	XC3	10/8	14	16	39	6.5

## ELBOW, MALE CONICAL (XC5)

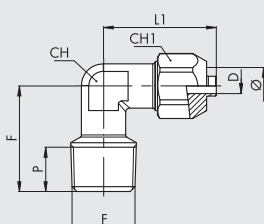

Code	Ref.	Ø	F	Ch	Ch1	P	L	L1	D
2305001X	XC5	6/4	1/8	10	12	7.5	17	23	3
2305002X	XC5	6/4	1/4	10	12	11	21.5	23	3
2305003X	XC5	8/6	1/8	10	14	7.5	17	23	5
2305004X	XC5	8/6	1/4	10	14	11	21.5	23	5
2305006X	XC5	10/8	1/4	10	16	11	21.5	25.5	6.5

**ELBOW CONNECTOR (XC6)**

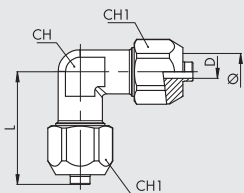

Code	Ref.	Ø	Ch	Ch1	L	D
2306001X	XC6	6/4	10	12	22.5	3
2306002X	XC6	8/6	10	14	23	5
2306003X	XC6	10/8	10	16	25.5	6.5

**TEE, CENTRAL MALE (XC7)**

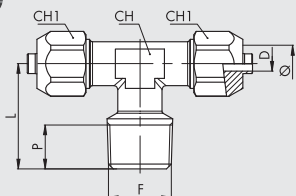

Code	Ref.	Ø	F	Ch	Ch1	P	L	L1	D
2307001X	XC7	6/4	1/8	10	12	8	17	23	3
2307002X	XC7	6/4	1/4	10	12	11	21.5	23	3
2307003X	XC7	8/6	1/8	10	14	8	17	23	5
2307004X	XC7	8/6	1/4	10	14	11	21.5	23	5
2307006X	XC7	10/8	1/4	10	16	11	21.5	25.5	6.5

**TEE, LATERAL MALE (XC8)**

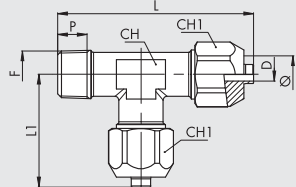

Code	Ref.	Ø	F	Ch	Ch1	P	L	L1	D
2308001X	XC8	6/4	1/8	10	12	8	40	23	3
2308002X	XC8	6/4	1/4	10	12	11	44.5	23	3
2308003X	XC8	8/6	1/8	10	14	8	40	23	5
2308004X	XC8	8/6	1/4	10	14	11	44.5	23	5
2308006X	XC8	10/8	1/4	10	16	11	47	25.5	6.5

**TEE CONNECTOR (XC9)**

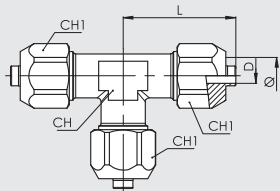

Code	Ref.	Ø	Ch	Ch1	L	D
2309001X	XC9	6/4	10	12	22.5	3
2309002X	XC9	8/6	10	14	23	5
2309003X	XC9	10/8	10	16	25.5	6.5

**NUT (XC10)**

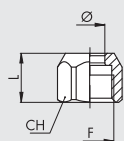

Code	Ref.	Ø	F	Ch1	L
2310002X	XC10	6/4	M10x1	12	10
2310004X	XC10	8/6	M12x1	14	10
2310005X	XC10	10/8	M14x1	16	11