

A TYPE – FEATURES

Original Saunders® Design

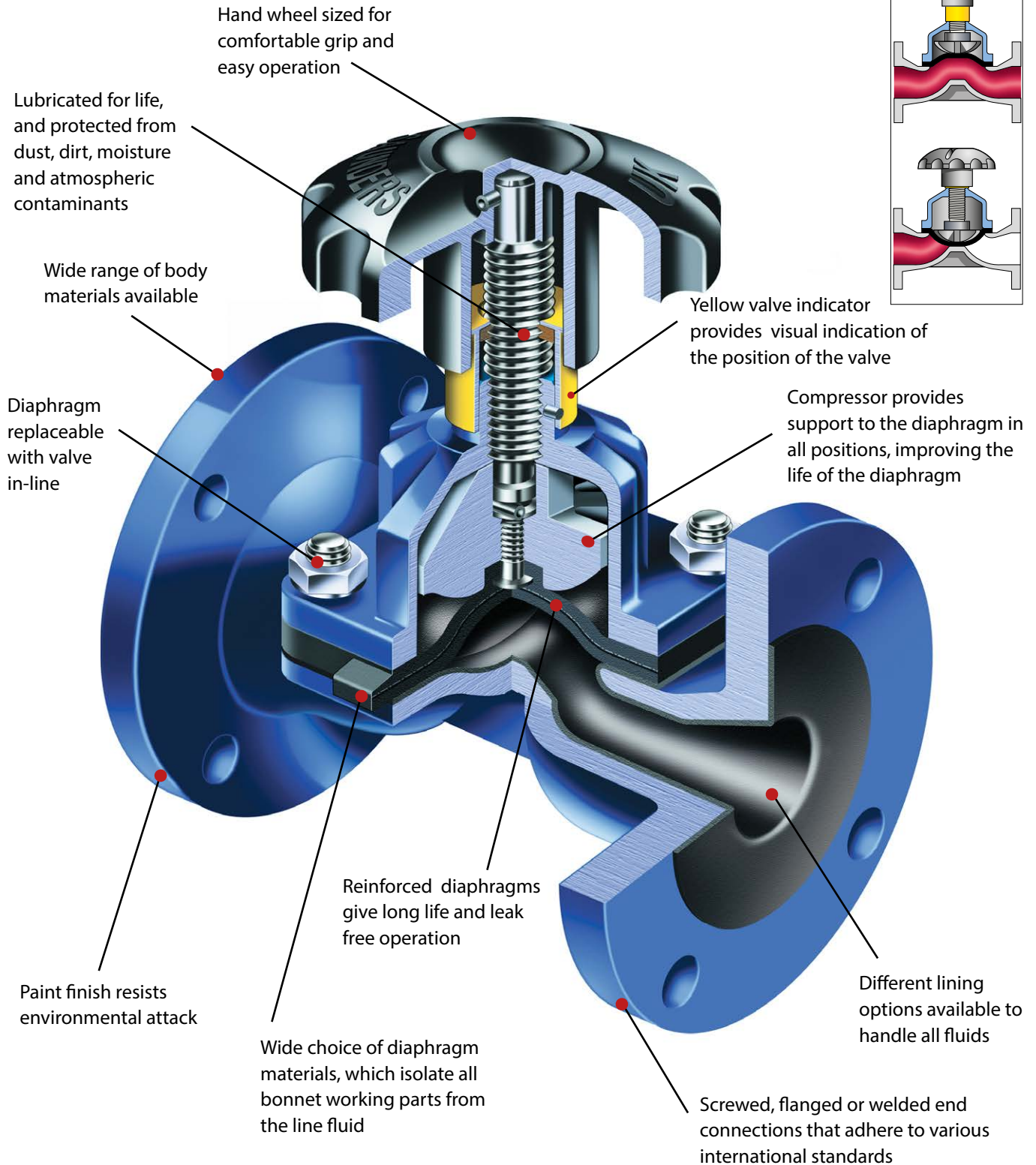

**Saunders® A type Diaphragm Valve:
the valve of choice to handle highly corrosive media**

A TYPE – STANDARDS



Top Works

- Manual
- Actuated

Diaphragm

- Rubber
- PTFE

Body

- Flanged and screwed design
- Lined and unlined
- Cast iron, SG iron, cast steel, stainless steel or gunmetal

As well as meeting the overall lengths specified in EN 558-1 Series 1, Series 7* and MSS SP-88, Saunders® valves are manufactured to the following standards:

Flanged	
American	ASME B16.1 Class 125
	ASME B16.24 Class 150
	ASME B16.5 Class 150
British	BS 10 Tables D and E
British/European¹	BS EN 1092-1 PN10/16
	BS EN 1092-2 PN10/16
	BS EN 1092-3 PN10/16
Japanese	JIS B 2220 10K
	JIS B 2239 10K
	JIS B 2240 10K

¹ Replaces BS 4504 PN10/16

Screwed	
American²	ASME B1.20.1
British/European³	BS EN 10226-1 Parallel
	BS EN 10226-1 Taper
European⁴	EN ISO 228-1
International	ISO 7-1 Parallel
	ISO 7-1 Taper

² Replaces ANSI 2.1

³ Replaces BS 21 Parallel and Taper

⁴ Replaces DIN 259

* Series 7 is the original IDV standard from when PK Saunders invented the diaphragm valve.

A TYPE – BODY

Lined and Unlined Options

Our metal bodies provide simultaneous mechanical support for the lining and protection against Ultraviolet (UV) attack. The nominal bore thicknesses of Saunders® linings range from 1 to 5.5 mm, depending on lining material and valve size: glass 1 mm, rubber 2-4.5 mm and plastic 4-5.5 mm.

Unlined Bodies

Material	Connection	Standard	Material Grade	Size	Temperature
Cast Iron	Flanged	BS EN1561	GJL-250	DN15-DN500	-10°C to 175°C
SG Iron	Screwed	BS EN1563	GJS-450-10	DN8-DN50	-10°C to 175°C
	Flanged		GJS-400-18 ¹	DN15-DN350	
Cast Steel	Flanged	ASTM A216	WCB	DN15-DN250	-30°C to 175°C
Gun Metal	Screwed	BS EN1982	CC491K-GS	DN8-DN80	-30°C to 175°C
	Flanged		CC492K-GS	DN15-DN200	
Stainless Steel	Screwed	BS EN10283	1.4408 ²	DN8-DN80	-30°C to 175°C
	Flanged			DN15-DN200	

¹ For some sizes GJS-400-18-LT grade is available with a low temperature limit of -20°C

² Replaces the standard BS3100 316C16

Standard material grade fasteners:

Stainless steel fasteners - All stainless steel, plastic lined and glass lined valves

Aluminium Bronze fasteners - Gunmetal flanged valves

Carbon Steel fasteners - All remaining valves.

Special material grade fasteners available upon request

Lined Options - Flanged Bodies Only

Lining	Body Material	Size	Temperature
PFA	SG Iron	DN15-DN200	-10°C to 175°C
ETFE	SG Iron	DN15-DN150	-10°C to 150°C
PVDF	SG Iron	DN20-DN150	-10°C to 125°C
PP	SG Iron	DN20-DN150	-10°C to 85°C

Glass	Cast Iron	DN15-DN200	-10°C to 175°C
-------	-----------	------------	----------------

Butyl (Isobutylene Isoprene)	Cast Iron	DN20-DN500	-10°C to 110°C
	SG Iron		-10°C to 110°C
	Cast Steel		-30°C to 110°C
Neoprene (Polychloroprene)	Cast Iron	DN20-DN500	-10°C to 105°C
	SG Iron		-10°C to 105°C
	Cast Steel		-30°C to 105°C
HRL (Hard Natural Rubber)	Cast Iron	DN20-DN500	-10°C to 85°C
	SG Iron		-10°C to 85°C
	Cast Steel		-30°C to 85°C

Plastic Lining



PFA Perfluoroalkoxy – Excellent suitability for concentrated strong acids at high temperature, aromatics, aliphatic and chlorinated solvents. (White colour)



ETFE Ethylene Tetrafluoroethylene – Suitable for strong acids, salts in water, solvents at medium temperature. ETFE has the highest abrasion resistance of all the fluorocarbon linings. (Red colour)



PP Polypropylene – Economic solution for mineral acids, salts in water, de-ionised water and effluent treatment chemicals. (Light grey colour)



PVDF Polyvinylidene Fluoride – Suitable for mineral acids, salts in water, water and effluent treatment, additionally it is the best solution for wet chlorine gas or chlorine in water. (Black colour)



Glass Lining



Used in many different applications, including strong acids. Very high corrosion and abrasion resistance within a wide range of temperature. *Note that glass is not suitable for applications where thermal cycling occurs.* (Blue colour)

Corrosion & Chemical Resistance

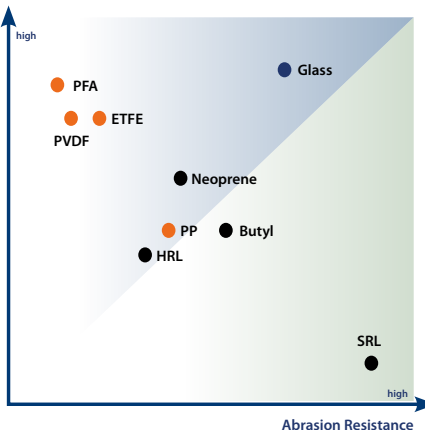

Rubber Lining



HRL Hard Natural Rubber – Used for salts in water, diluted acids, de-ionised water, plating solutions and potable water. HRL has better chemical resistance than SRL. (Black)

Butyl Isobutylene Isoprene – Great for corrosive & abrasive slurries, and acidic slurries. Additional applications are salts in water, dilute acids and alkalis, and lime. (Black)

Neoprene Polychloroprene – Perfect solution for a combination of abrasive slurries containing hydrocarbons, sludge oils and also sea water. (Black)

The temperature ranges above are given for general reference purposes only. Service conditions, such as media being handled and concentration of solids, will determine the highest possible working temperature. Additionally, the performance of the valve will also depend on the diaphragm material.

A TYPE – DIAPHRAGM

A Type Diaphragm

Diaphragm	Composition	Size	Temperature
425	EPM (Ethylene Propylene)	All Sizes	-40°C to 130°C
300	Butyl (Isobutylene Isoprene)	All Sizes	-40°C to 130°C
237	CSM (Chlorosulfonated Polyethylene)	All Sizes	-10°C to 100°C
XA	EPDM (Ethylene Propylene Diene)	All Sizes	-40°C to 130°C
HT	Neoprene (Polychloroprene)	All Sizes	-30°C to 100°C
226	FKM (Fluoroelastomer)	All Sizes	-5°C to 150°C
C	Nitrile (Butadiene Acrylonitrile)	All Sizes	-20°C to 100°C
Q	Natural Rubber	All Sizes	-50°C to 100°C

214/300	PTFE/Butyl	DN8-DN250	-20°C to 150°C
214/425	PTFE/EPM	DN8-DN250	-20°C to 160°C
214/226	PTFE/FKM	DN8-DN250	-5°C to 175°C
214S/425	TFM/EPM	DN8-DN150	-20°C to 160°C
214K/425	PTFE/PVDF/EPM	DN15-DN150	-20°C to 100°C

In the range of PTFE diaphragms, Saunders offers both moulded open and closed options for your convenience. The 214S is available as moulded closed and was designed specifically to reduce polymeric creep, therefore increasing the sealing properties and life of the diaphragm.



Moulded closed



Moulded open

PTFE Diaphragm

214/300 - Used in strong acids and alkalis, and salts in water at high temperature. Sulfuric acid is a good example with temperatures up to 110°C and concentrations up to 96 %.

214/425 - Typical applications are strong acids, alkalis and salts in water at high temperature. Constant steam is also another important application.

214/226 - Strong acid, diluted chlorine, bromine solutions at low concentration.

214S/425 - Strong acids, alkalis and salts in water at high temperature. Constant steam applications where the valve is mainly closed (diaphragm is moulded closed).

214K/425 - Three layer diaphragm with PTFE/PVDF/425, the best option for chlorine, bromine gas and chlorinated solutions.

Rubber Diaphragm

425 - Salts in water, acids and alkalis, ozone, water, intermittent steam. Great solution for food and beverages applications. FDA and USP approved¹.

300 - Chemicals, diluted acids and alkalis, drinking water. Additional abrasive applications like phosphoric acid in low concentrations. FDA, USP and WRAS approved¹.

237 - The best solution for sodium hypochlorite. Great with strong acids and low concentration chlorine gas. It is also oil resistant.

XA - Specifically designed for both abrasive and corrosive applications such as phosphoric acid, metal treatment, mining applications.

HT - Suitable for abrasive slurries containing hydrocarbons.

226 - Great solution for hydrogen at high temperature, concentrated acids, aromatic solvents, low concentrated chlorine solutions, ozone, unleaded petroleum.

C - Lubricating oil, cutting oils, paraffin, animal vegetable oils, aviation kerosene at low temperatures. Cv is ideal for vacuum applications, where oils are present, e.g. (compressed air, acetylene gas, LPG).

Q - Salts in water, diluted acids and alkalis, and abrasive applications.

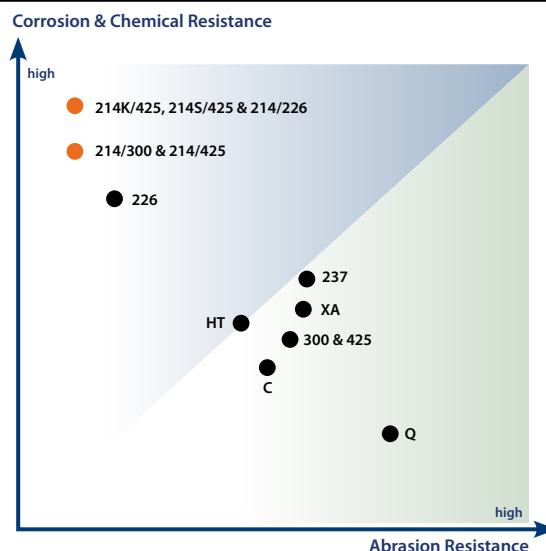

¹ FDA - Food and Drug Administration

USP - United States Pharmacopeia

WRAS - Water Regulations Advisory Scheme

All rubber diaphragms have threaded brass fixings, except vacuum diaphragm (Cv, 300v, 425v), which have steel fitments. PTFE diaphragms have a stainless steel bayonet fitments.

A TYPE – DIAPHRAGM DIMENSIONS

Diaphragm Identification

Back Face

Size



Grade identification

Wetted Face



Week Year

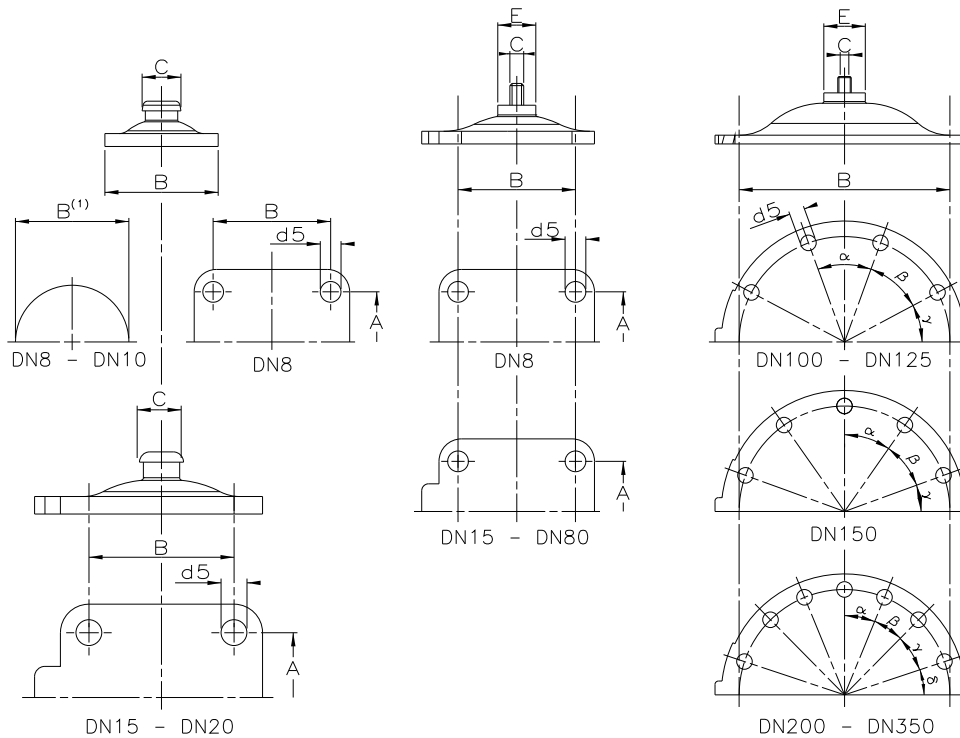

Size (DN)	Principal Diaphragm Dimensions							Angles from the holes			
	A	B	C	D (thickness)	E	d5	Number of Holes	α	β	γ	δ
8	35	28	9.5	3.2	-	5	2	-	-	-	-
10	43	35	10	4	-	6	2	-	-	-	-
15	33	37	13	5	-	6	4	-	-	-	-
20	40	44	13	5.4	-	7	4	-	-	-	-
25	46	54	1/4" BSW	5.5	17.5	10	4	-	-	-	-
32	60	67		7.2	19	10	4	-	-	-	-
40	65	70		6	22	11	4	-	-	-	-
50	78	83	5/16" BSW	6.2	25.4	13	4	-	-	-	-
65	95	102		7.9	28.6	14	4	-	-	-	-
80	114	127	3/8" BSW	7	32	17	4	-	-	-	-
100	-	194		8	38	14	8	40°	42°	56°	-
125	-	222	7/8" BSW	11.1	44.5	17	8	43°20'	43°20'	50°	-
150	-	273		11.9	50	17	10	35°	35°	40°	-
200	-	381	7/8" BSW	10	63.5	19	14	22°30'	22°30'	27°	36°
250	-	438		14	76	22	14	22°30'	22°30'	22°30'	45°
300	-	508		15.2	89	25	14	24°	24°	24°	36°
350	-	527	15.9								

BSW=British Standard Whitworth thread

Note: Dimensions in mm unless otherwise stated.



A TYPE – TOP WORKS

Standard Range

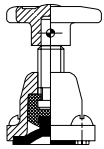

Rising handwheel (2 bolt)
DN8 - DN10

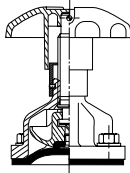

Cast iron bonnet with rising plastic handwheel
DN15 - DN50

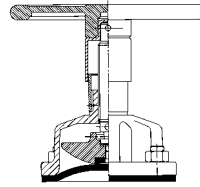

Cast iron bonnet with rising metal handwheel
DN15 - DN150

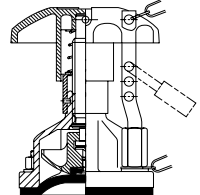

Rising handwheel with indicator (simple padlocking)
DN15 - DN150

High Performance

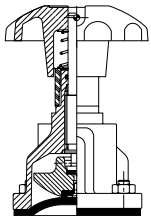

Fluoroelastomer sealed bonnet
DN15 - DN150

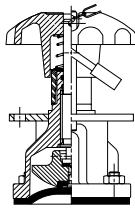

Fluoroelastomer sealed with padlocking
DN15 - DN150

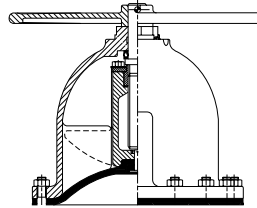

Standard non-rising handwheel without indicator
DN200 - DN350

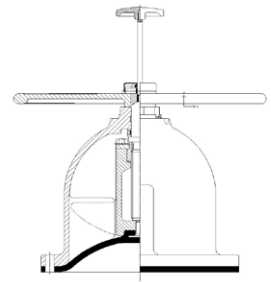

Non-Rising handwheel with indicator
DN200 - DN350

Note: Designs may vary across size range

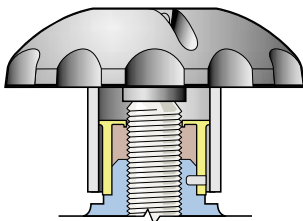

Lubrication

Bonnet assembly lubricated for life. Needs no additional grease. The indicator lip seal stops the ingress of dust, dirt and atmospheric contaminants.

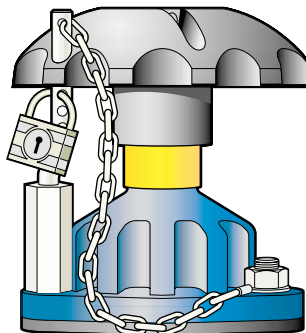

Padlock Bonnet

Restricted valve operation can be achieved by utilizing the padlocking bonnet option.

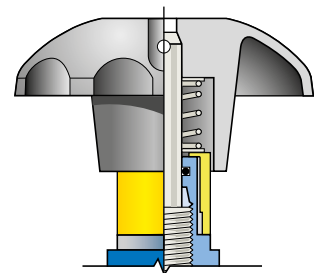

Sealed Bonnet

In cases where hazardous liquids or gases are being handled and where additional safety features are considered to be necessary.

A TYPE – PRESSURE & TEMPERATURE LIMITS

Maximum manual working pressures for Saunders[®] A type diaphragm valves.
For actuated valves, please refer to the appropriate datasheets.

Bonnet pressure limits

		Size (DN)	8	10	15	20	25	32	40	50	65	80	100	125	150	200	250	300	350	
		Diaphragm	Handwheel																	
Pressure (bar)	PTFE	Rising	10	10	10	10	10	10	10	10	10	10	10	10	10	7	-	-	-	-
		Non-rising	-	-	-	-	-	-	-	-	-	-	-	-	-	-	6	5	-	-
	Rubber	Rising	16	16	16	16	16	16	16	16	16	10	10	10	10	10	-	-	-	-
		Non-rising	-	-	-	-	-	-	-	-	-	-	-	-	-	-	6	5	4	3.5

All Saunders[®] valves are pressure tested in accordance with BS EN12266-1 standard.

- Shell test: 1.5 times maximum rated working pressure
- Seat test: 1.1 times maximum rated working pressure

Pressure/Temperature Relationships

Cast Iron and SG Iron

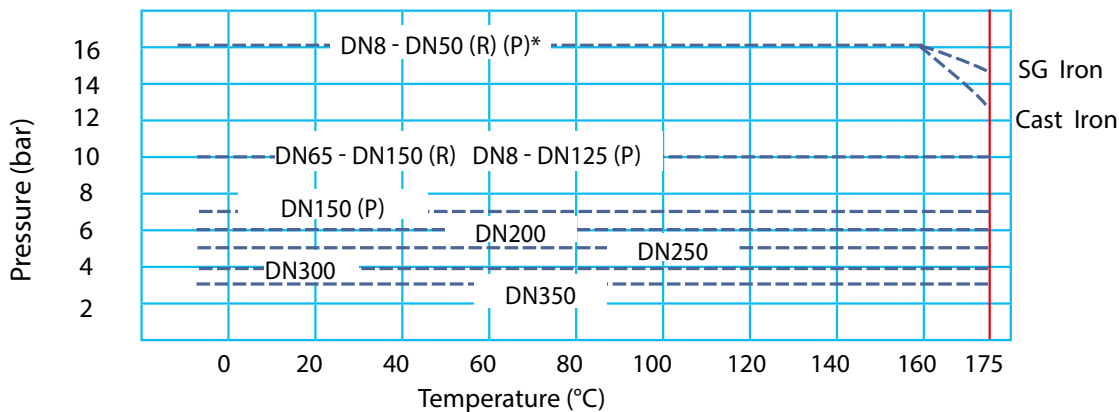

Carbon Steel, Stainless Steel & Gunmetal

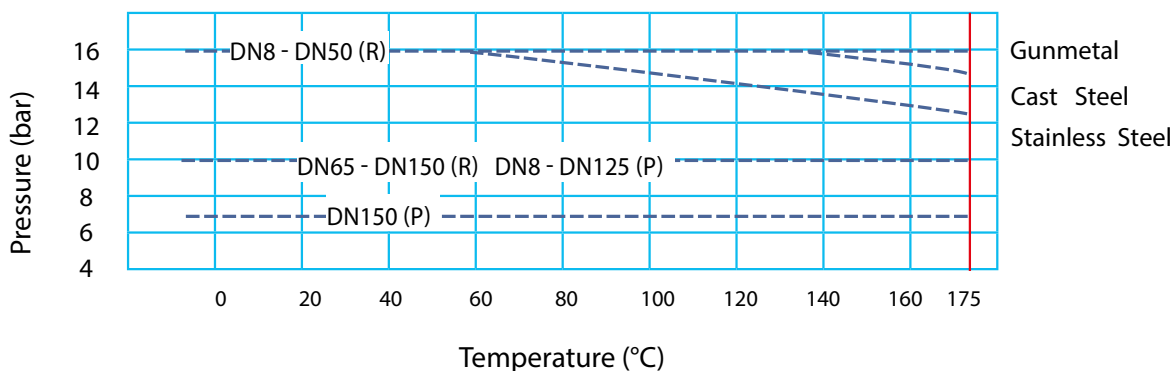

(R) = Rubber diaphragm
(P) = PTFE diaphragm
* 214S Moulded closed version only

A TYPE – ASSEMBLED VALVE DIMENSIONS

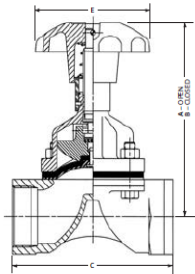

Screwed DN8-DN80

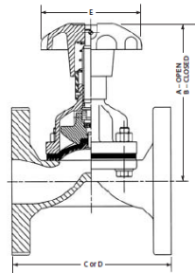

Flanged DN15-DN50

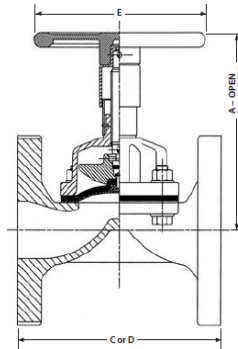

Flanged DN65-DN150

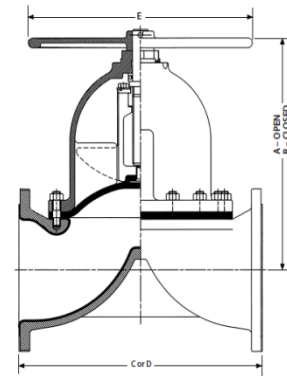

Flanged DN200-DN350

Size (DN)	8	10	15	20	25	32	40	50	65	80	100	125	150	200	250	300	350	
Screwed Unlined	A	54	67	90	94	119	154	164	188	241	263	-	-	-	-	-	-	
	B	52	61	84	88	108	142	148	164	209	229	-	-	-	-	-	-	
	C	49	49	64	83	111	125	145	168	206	257	-	-	-	-	-	-	
	Weight	0.11	0.15	0.45	0.9	1.13	1.8	3	5	9	13	-	-	-	-	-	-	
Flanged Unlined	A	-	-	100	91	108	143	157	175	226	243	308	388	442	495	581	679	660
	B	-	-	93	85	98	131	141	152	194	208	262	322	367	495	581	679	660
	C	-	-	108	117	127	146	159	190	216	254	305	356	406	521	635	749	749
	D	-	-	130	150	160	180	200	230	290	310	350	400	480	600	730	850	980
	Weight	-	-	2	2	3	4	5	8	14	19	32	48	63	152	270	360	506
Flanged Rubber Lined	A	-	-	-	97	111	146	160	177	229	246	311	391	445	498	585	683	664
	B	-	-	-	91	101	134	144	154	197	212	265	325	370	498	585	683	664
	C	-	-	-	121	131	150	163	194	220	258	309	362	412	527	641	755	755
	D	-	-	-	150	160	180	200	230	290	310	350	400	480	600	730	850	980
	Weight	-	-	-	3	4	5	6	9	15	21	32	50	63	154	273	365	512
Flanged Glass/Halar Lined	A	-	-	101	92	109	144	158	176	227	244	309	389	443	496	582	680	661
	B	-	-	94	86	99	132	142	153	195	210	263	323	368	496	582	680	661
	C	-	-	110	119	129	148	161	192	218	256	307	358	408	523	637	751	751
	D	-	-	130	150	160	180	200	230	290	310	350	400	480	600	730	850	980
	Weight	-	-	2	2	4	5	6	9	15	20	33	49	63	153	272	362	508
Flanged Plastic Lined	A	-	-	-	97	112	147	162	179	230	246	313	391	450	-	-	-	-
	B	-	-	-	91	101	133	145	155	198	211	267	322	374	-	-	-	-
	C	-	-	-	123	133	152	165	196	222	260	311	356	412	-	-	-	-
	D	-	-	-	150	160	180	200	230	290	310	350	394	480	-	-	-	-
	Weight	-	-	-	3	4	5	6	9	15	21	34	50	63	-	-	-	-
E	38	50	62	62	80	120	120	120	170	230	280	280	368	482	584	699	699	

Note: Dimensions in mm. Weights in kg. Weight may vary with materials, lining and standards. For exact weights please contact Saunders®. C valve length = EN 558 Series 7 (ex BS 5156). D valve length = EN 558 Series 1 (ex DIN 3202 Series F1).

Glass lining is typically available in the size range DN15 - DN200 for A Type valves. Contact Saunders® for further requirements.

A TYPE – FLOW COEFFICIENTS

DN15										
% Open	Body Material / Lining									
	Cast (Unlined)		Rubber Lined		Glass / Halar		Plastic Lined			
	Cv	Kv	Cv	Kv	Cv	Kv	Cv	Kv		
100	5.5	4.8	-	-	6.0	5.2	-	-		
90	5.3	4.6	-	-	5.8	5.0	-	-		
80	5.1	4.4	-	-	5.5	4.8	-	-		
70	4.8	4.2	-	-	5.3	4.6	-	-		
60	4.6	4.0	-	-	5.0	4.4	-	-		
50	3.8	3.3	-	-	4.2	3.6	-	-		
40	3.1	2.7	-	-	3.4	2.9	-	-		
30	2.3	2.0	-	-	2.5	2.2	-	-		
20	1.5	1.3	-	-	1.7	1.4	-	-		
10	0.8	0.7	-	-	0.8	0.7	-	-		
0	0	0	-	-	0	0	-	-		

DN20										
% Open	Body Material / Lining									
	Cast (Unlined)		Rubber Lined		Glass / Halar		Plastic Lined			
	Cv	Kv	Cv	Kv	Cv	Kv	Cv	Kv		
100	12	9.9	9.2	8.0	12	10	6.5	6		
90	11	9.5	9.0	7.8	12	10	6.2	5		
80	11	9.1	8.8	7.6	11	9.5	6.0	5		
70	10	8.8	8.4	7.3	11	9.1	5.7	5		
60	9.7	8.4	7.7	6.7	10	8.7	5.5	5		
50	8.1	7.0	6.7	5.8	8.4	7.3	4.5	4		
40	6.4	5.6	5.5	4.8	6.7	5.8	3.6	3		
30	4.8	4.2	4.1	3.5	5.0	4.4	2.7	2		
20	3.2	2.8	2.5	2.2	3.4	2.9	1.8	2		
10	1.6	1.4	1.0	0.9	1.7	1.4	0.9	1		
0	0	0	0	0	0	0	0	0		

DN25										
% Open	Body Material / Lining									
	Cast (Unlined)		Rubber Lined		Glass / Halar		Plastic Lined			
	Cv	Kv	Cv	Kv	Cv	Kv	Cv	Kv		
100	18	15	14	12	18	16	11	9.7		
90	16	14	14	12	17	15	11	9.3		
80	16	14	13	12	17	14	10	8.9		
70	15	13	13	11	16	14	9.9	8.5		
60	15	13	12	10	15	13	9.4	8.1		
50	12	11	10	9	13	11	7.8	6.8		
40	9.9	8.5	8.4	7.3	10	8.7	6.3	5.4		
30	7.4	6.4	6.3	5.4	7.6	6.5	4.7	4.1		
20	4.9	4.3	3.8	3.3	5.0	4.4	3.1	2.7		
10	2.5	2.1	1.5	1.3	2.5	2.2	1.6	1.3		
0	0	0	0	0	0	0	0	0		

DN32										
% Open	Body Material / Lining									
	Cast (Unlined)		Rubber Lined		Glass / Halar		Plastic Lined			
	Cv	Kv	Cv	Kv	Cv	Kv	Cv	Kv		
100	28	24	22	19	28	24	17	14		
90	26	23	21	18	27	23	16	14		
80	25	22	20	18	26	22	15	13		
70	24	21	19	17	25	21	15	13		
60	23	20	18	16	24	20	14	12		
50	19	17	15	13	20	17	12	10		
40	15	13	12	11	16	14	9.4	8.1		
30	12	10	9.2	8.0	12	10	7.0	6.1		
20	7.7	6.7	6.2	5.3	7.8	6.8	4.7	4.0		
10	3.8	3.3	3.1	2.7	3.9	3.4	2.3	2.0		
0	0	0	0	0	0	0	0	0		

DN40										
% Open	Body Material / Lining									
	Cast (Unlined)		Rubber Lined		Glass / Halar		Plastic Lined			
	Cv	Kv	Cv	Kv	Cv	Kv	Cv	Kv		
100	43	37	35	30	45	39	31	27		
90	41	36	34	29	43	37	30	26		
80	40	34	34	29	41	36	29	25		
70	38	33	32	28	40	34	27	24		
60	36	31	29	25	38	33	26	23		
50	30	26	26	22	32	27	22	19		
40	24	21	21	18	25	22	17	15		
30	18	16	16	14	19	16	13	11		
20	12	10	9.5	8.2	13	11	8.7	7.5		
10	6.0	5.2	3.9	3.4	6.3	5.4	4.3	3.7		
0	0	0	0	0	0	0	0	0		

DN50										
% Open	Body Material / Lining									
	Cast (Unlined)		Rubber Lined		Glass / Halar		Plastic Lined			
	Cv	Kv	Cv	Kv	Cv	Kv	Cv	Kv		
100	80	69	64	55	88	76	59	51		
90	77	66	63	54	84	73	56	48		
80	74	64	61	53	81	70	54	47		
70	70	61	58	50	77	67	52	45		
60	67	58	53	46	74	64	50	43		
50	56	48	47	41	62	53	41	35		
40	45	39	38	33	49	43	33	29		
30	34	29	29	25	37	32	25	22		
20	22	19	17	15	25	21	16	14		
10	11	9.7	7.0	6.1	12	11	8.0	6.9		
0	0	0	0	0	0	0	0	0		

DN65										
% Open	Body Material / Lining									
	Cast (Unlined)		Rubber Lined		Glass / Halar		Plastic Lined			
	Cv	Kv	Cv	Kv	Cv	Kv	Cv	Kv		
100	127	110	102	88	132	114	83	72		
90	121	105	98	85	126	109	80	69		
80	116	100	94	81	121	105	76	66		
70	111	96	90	78	116	100	73	63		
60	106	92	86	74	110	95	70	60		
50	89	77	71	62	92	80	58	50		
40	71	62	57	49	74	64	47	40		
30	53	46	43	37	55	48	35	30		
20	36	31	29	25	37	32	23	20		
10	18	15	14	12	19	16	12	10		
0	0	0	0	0	0	0	0	0		

DN80										
% Open	Body Material / Lining									
	Cast (Unlined)		Rubber Lined		Glass / Halar		Plastic Lined			
	Cv	Kv	Cv	Kv	Cv	Kv	Cv	Kv		
100	185	160	148	128	186	161	148	128		
90	177	153	145	125	178	154	142	123		
80	170	147	142	123	171	148	136	118		
70	162	140	135	117	163	141	130	113		
60	155	134	123	106	156	135	124	107		
50	129	112	108	93	130	113	103	89		
40	103	89	89	77	104	90	83	72		
30	78	67	67	58	78	68	62	54		
20	52	45	40	35	52	45	41	36		
10	26	22	16	14	26	23	20	18		
0	0	0	0	0	0	0	0	0		

DN100										
% Open	Body Material / Lining									
	Cast (Unlined)		Rubber Lined		Glass / Halar		Plastic Lined			
	Cv	Kv	Cv	Kv	Cv	Kv	Cv	Kv		
100	315	273	252	218	336	291	270	234		
90	302	261	247	214	322	279	259	224		
80	289	250	242	203	309	267	248	215		
70	277	240	229	198	295	255	237	205		
60	264	228	209	181	282	244	226	196		
50	220	190	184	159	235	203	189	164		
40	176	152	151	131	188	163	151	131		
30	132	114	113	98	141	122	113	98		
20	88	73	68	59	94	81	76	65		
10	44	38	28	24	47	41	38	33		
0	0	0	0	0	0	0	0	0		

Cv = flow in US gal/min through a valve with ΔP = 1 psi

Kv = flow in m³/hr through a valve with ΔP = 1 bar

$$1.156 Kv = Cv$$

Note: All Kv and Cv values shown here refer to flanged valves. Valves with screwed ends demonstrate different Kv/Cv values. For more information contact Saunders[®].

A TYPE – FLOW COEFFICIENTS

DN125									
% Open	Body Material / Lining								
	Cast (Unlined)		Rubber Lined		Glass / Halar		Plastic Lined		
	Cv	Kv	Cv	Kv	Cv	Kv	Cv	Kv	
100	420	363	363	314	440	381	-	-	
90	403	349	348	301	422	365	-	-	
80	386	334	333	288	404	349	-	-	
70	369	319	319	276	387	335	-	-	
60	352	304	304	263	369	319	-	-	
50	294	254	254	220	308	266	-	-	
40	235	203	203	176	246	213	-	-	
30	176	152	152	131	184	159	-	-	
20	117	101	101	87	123	106	-	-	
10	59	51	51	44	62	54	-	-	
0	0	0	0	0	0	0	-	-	

DN150									
% Open	Body Material / Lining								
	Cast (Unlined)		Rubber Lined		Glass / Halar		Plastic Lined		
	Cv	Kv	Cv	Kv	Cv	Kv	Cv	Kv	
100	605	523	484	419	630	545	505	437	
90	580	502	474	410	604	522	484	419	
80	556	481	465	402	579	501	464	401	
70	532	460	440	381	554	479	444	384	
60	508	439	402	348	529	458	424	367	
50	423	366	353	305	441	381	353	305	
40	338	292	290	251	352	304	282	244	
30	254	220	218	189	264	228	212	183	
20	169	146	131	113	176	152	141	122	
10	85	74	53	46	88	76	71	61	
0	0	0	0	0	0	0	0	0	

DN200									
% Open	Body Material / Lining								
	Cast (Unlined)		Rubber Lined		Glass / Halar		Plastic Lined		
	Cv	Kv	Cv	Kv	Cv	Kv	Cv	Kv	
100	1300	1125	1309	1132	1320	1142	-	-	
90	1248	1080	1256	1087	1267	1096	-	-	
80	1196	1035	1204	1042	1214	1050	-	-	
70	1144	990	1151	996	1161	1004	-	-	
60	1092	945	1099	951	1108	958	-	-	
50	910	787	916	792	924	799	-	-	
40	728	630	733	634	739	639	-	-	
30	546	472	549	475	554	479	-	-	
20	364	315	366	317	369	319	-	-	
10	182	157	183	158	184	159	-	-	
0	0	0	0	0	0	0	-	-	

DN250									
% Open	Body Material / Lining								
	Cast (Unlined)		Rubber Lined		Glass / Halar ¹		Plastic Lined		
	Cv	Kv	Cv	Kv	Cv	Kv	Cv	Kv	
100	1980	1713	2000	1730	2100	1817	-	-	
90	1900	1644	1920	1661	2016	1744	-	-	
80	1821	1575	1840	1592	1932	1671	-	-	
70	1742	1507	1760	1522	1848	1599	-	-	
60	1663	1439	1679	1452	1763	1525	-	-	
50	1386	1199	1400	1211	1470	1272	-	-	
40	1108	958	1120	969	1176	1017	-	-	
30	831	719	839	726	881	762	-	-	
20	554	479	560	484	588	509	-	-	
10	277	240	280	242	294	254	-	-	
0	0	0	0	0	0	0	-	-	

DN300									
% Open	Body Material / Lining								
	Cast (Unlined)		Rubber Lined		Glass / Halar ¹		Plastic Lined		
	Cv	Kv	Cv	Kv	Cv	Kv	Cv	Kv	
100	2550	2206	2600	2249	2700	2336	-	-	
90	2448	2118	2496	2159	2592	2242	-	-	
80	2346	2029	2392	2069	2484	2149	-	-	
70	2244	1941	2288	1979	2376	2055	-	-	
60	2142	1853	2184	1889	2268	1962	-	-	
50	1785	1544	1820	1574	1890	1635	-	-	
40	1428	1235	1456	1260	1512	1308	-	-	
30	1071	926	1092	945	1134	981	-	-	
20	714	618	728	630	756	654	-	-	
10	357	309	364	315	378	327	-	-	
0	0	0	0	0	0	0	-	-	

DN350									
% Open	Body Material / Lining								
	Cast (Unlined)		Rubber Lined		Glass / Halar ¹		Plastic Lined		
	Cv	Kv	Cv	Kv	Cv	Kv	Cv	Kv	
100	3700	3201	3750	3244	3880	3356	-	-	
90	3552	3073	3500	3028	3724	3221	-	-	
80	3404	2945	3450	2984	3569	3087	-	-	
70	3256	2817	3300	2855	3414	2953	-	-	
60	3107	2688	3149	2724	3259	2819	-	-	
50	2590	2240	2625	2271	2716	2349	-	-	
40	2072	1792	2100	1817	2172	1879	-	-	
30	1553	1343	1574	1362	1629	1409	-	-	
20	1036	896	1050	908	1086	939	-	-	
10	518	448	525	454	543	470	-	-	
0	0	0	0	0	0	0	-	-	

¹ Glass lining is typically available in the size range DN15 - DN200 for A Type valves. Contact Saunders® for further requirements.

Cv = flow in US gal/min through a valve with ΔP = 1 psi

Kv = flow in m³/hr through a valve with ΔP = 1 bar

$$1.156 Kv = Cv$$

Variations in Flow Coefficients (Cv and Kv) ratings can be derived depending on the test method used. The flow coefficient provides a measure of the flow capacity of a valve. It is defined as the volume flow of water at a controlled temperature and a given pressure drop across the valve. This coefficient allows engineers to compare flow capacities of valves of different sizes, types and manufacturers.